

LEVEL GAUGE WITH VALVE L 135

FEATURES

The brass level indicator L 135 is dedicated to the visual indication of a tank level. The indicator give a direct reading of the level through a transparent tube. It is provided with two needle valves allowing isolating the tube of reading. It can be equipped with plastic or glass transparent tube.

The indicator L 135 is an economic solution to the level visualization of clean, not aggressive liquids, at low pressure and ambient temperature.

AVAILABLE MODELS

Diameters 1/4" to 3/4".
BSP Thread end connections.



LIMITS OF USE

PS fluid :	10 bar
TS fluid :	-10 °C / + 90 °C

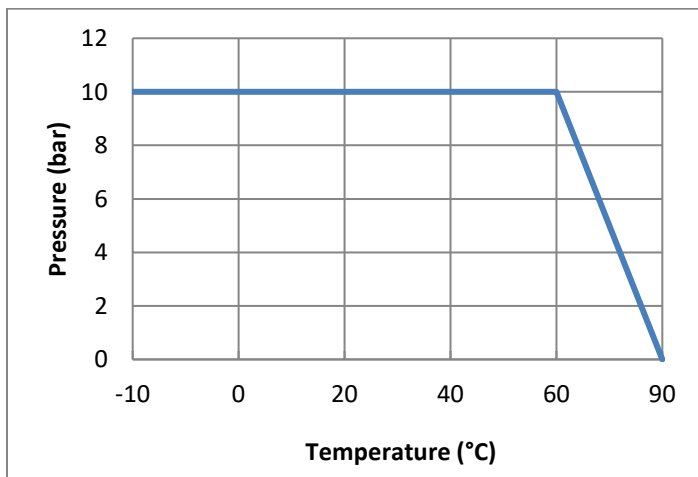

REGULATIONS AND STANDARD OF CONSTRUCTION

ITEM	Standard
P.E.D 2014/68	Excluded
Materials of brass	EN 1503-4
Thread	ISO 228

Information given as an indication only, and subject to possible modifications



SECTORIEL S.A.
45 rue du Ruisseau
38290 SAINT QUENTIN-FALLAVIER – FRANCE
Tél : +33 4 74 94 90 70 - Fax : +33 4 74 94 13 95
www.sectoriel.com / Email : sectoriel@sectoriel.fr

Pages	1/4
Ref.	FT2311 ENG
Rev.	03
Date	09/2023

LEVEL GAUGE WITH VALVE L 135

DIMENSIONS (mm) AND CONNECTIONS

CONNECTIONS	∅ Tube	A	A1	B	H1	H2	C	V	Weight (Kg).
G 3/8" M	13	43	19	38	71	38	17	55	0,7
G 1/2" M	13	43	19	42	71	42	18	55	0,7
G 1/2" M	16	43	19	42	71	42	18	55	0,7
G 3/4" M	18	48	24	46	83	45	15	59	1,1
G 3/4" M	20	48	24	46	83	45	15	59	0,9

CONSTRUCTION

N°	Item	Qty	Material
1	Body	2	Brass CW 614N
2	Nut of tightening	2	Brass
3	Guide ring	2	Brass
4	Hand wheel	2	Aluminium
5	Steam trap	1	Brass
6	Washer	2	Silicone
7	Tube	1	Plastic / Glass

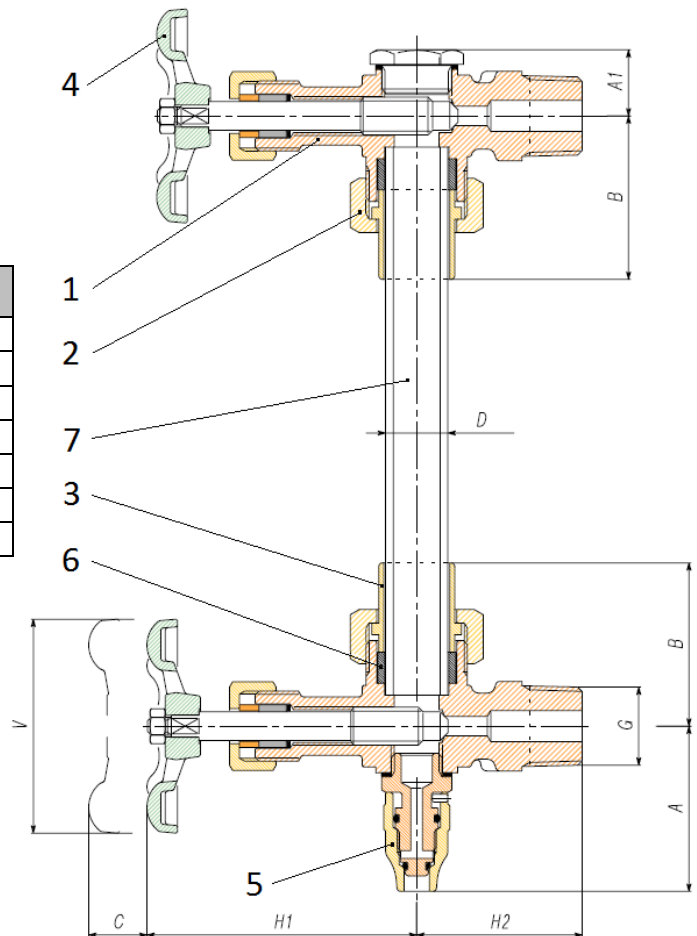

CALCULATION OF THE LENGH OF THE TUBE

Length of the tube is equal to the face to face dimension less 15mn.

Information given as an indication only, and subject to possible modifications





SECTORIEL S.A.
 45 rue du Ruisseau
 38290 SAINT QUENTIN-FALLAVIER – FRANCE
 Tél : +33 4 74 94 90 70 - Fax : +33 4 74 94 13 95
www.sectoriel.com / Email : sectoriel@sectoriel.fr

Pages	2/4
Ref.	FT2311 ENG
Rev.	03
Date	09/2023

LEVEL GAUGE WITH VALVE L 135

OPTIONS

Protection tube in brass U 2319		
∅ Tube (mm)	Code	
13	23191310	
16	23191610	
18	23191810	
20	23192010	

	T154 : Plastic tube PMMA	2314 : Tube pirex glass	
∅ Tube (mm)	Code	Code	
13	23181310	23141315	
16	23181610	23141615	
18	23181810	23141815	
20	23182010	23142015	

Intermediate connection 151			
∅ Tube (mm)	Fixation	Code	
13	G 1/2" M	2317413	
16	G 1/2" M	2317416	
18	G 3/4" M	2317518	
20	G 3/4" M	2317520	

MOUNTING

- 1 - Verify that the tank is empty.
- 2 - To install the level gauge, begin by screwing the bottom valve provided with the bleeder screw on the tank. To guarantee the tightness of the thread on the tank, use a material adapted to the type of fluid. Close the bleeder screw, as well as the valve.
- 3 - Then screw the top valve on the tank (Idem assembly bottom). Close the valve.
- 4 - To take up the tube, begin by unscrewing the set nut and guide ring of the bottom, crossing the tube in the guide ring, the nut and the washer. Insert, screw and tighten this assembly on the bottom.
- 5 - For the top, unscrew the set nut and guide ring. Take the face to face dimension between the bottom and top, to cut the tube in the appropriate length. (See above calculation of the length of the tube). Cross the tube in the guide ring, the nut and the washer. Insert, screw and tighten this assembly on the top.

USE

- 1 - Close the low bleeder screw.
- 2 - Open both valves bottom and top.
- 3 - See the level in the tube.

Information given as an indication only, and subject to possible modifications

	SECTORIEL S.A. 45 rue du Ruisseau 38290 SAINT QUENTIN-FALLAVIER – FRANCE Tél : +33 4 74 94 90 70 - Fax : +33 4 74 94 13 95 www.sectoriel.com / Email : sectoriel@sectoriel.fr	Pages	3/4
		Ref.	FT2311 ENG
		Rev.	03
		Date	09/2023

LEVEL GAUGE WITH VALVE L 135

MAINTENANCE

- 1 - Close both bottom and top valves.
- 2 - Empty the tank.
- 3 - Open the low bleeder screw and get back the fluid contained in the tube.
- 4 - Unscrew the lower and upper nuts of tightening of the tube.
- 5 - Remove the tube, wash it or replace it by a tube of the same reference as well as both washer.
- 6 - Tighten without excess the lower and upper nuts in order not to break the tube.
- 7 - Close the low bleeder screw and open again the lower and upper valves.

SPARE PARTS

Silicone washer for level gauge L135	
Ø Tube (mm)	Code
13	981026
13	981027
16	981028
18	981029

Information given as an indication only, and subject to possible modifications

	SECTORIEL S.A. 45 rue du Ruisseau 38290 SAINT QUENTIN-FALLAVIER – FRANCE Tél : +33 4 74 94 90 70 - Fax : +33 4 74 94 13 95 www.sectoriel.com / Email : sectoriel@sectoriel.fr	Pages	4/4
		Ref.	FT2311 ENG
		Rev.	03
		Date	09/2023